

**PurePRP® SupraPhysiologic Concentrating System**  
**GenesisCS Component Concentrating System**  
**Rev. 5**  
**Date: March 2023**

NOTE: DEVICE IS FOR SINGLE USE ONLY. Discard the entire disposable system after one use, using an acceptable disposal method for products potentially contaminated with blood.

**DESCRIPTION**

1. The PurePRP® Supraphysiologic Concentrating System is manufactured by EmCyte Corporation. The kit prepares platelet rich plasma from a small sample of blood at the point of care. The system contains syringes, needles and the concentrating device accessories.

**MATERIALS**

2. The materials used are syringes, needles, tubing, connectors, and concentrating devices. The materials consist of medical grade polymers, elastomers and stainless steel that are suitable for use in medical devices. All components in this system are packaged, labeled and sterilized as indicated by the manufacturer's labeling. All components in this system are latex-free.

**INDICATIONS FOR USE STATEMENTS**

3. The PurePRP® Supraphysiologic Concentrating System is designed to be used for the safe and rapid preparation of autologous platelet rich plasma (PRP) from a small sample of blood at the patient's point of care. The PRP is mixed with autograft and allograft bone prior to application to an orthopedic site to improve bone graft handling characteristics.
4. The safety and effectiveness of this device for in vivo indications for use, such as bone healing and hemostasis, have not been established.
5. The PRP prepared by this device has not been evaluated for any clinical indications.
6. The PRP prepared by this device is NOT indicated for delivery to the patient's circulatory system.

**USER POPULATION**

7. The intended user population is medical professionals who are licensed or certified in clinical practice. The operational context of the device requires users to be trained on aseptic technique and understand blood components. The surgeon is to be thoroughly familiar with the equipment and the surgical procedure prior to using this device.

**DEVICE USE ENVIRONMENT**

8. The device is intended to be used in a health care setting such as a surgery room, clinic or outpatient care center.

**WARNING AND PRECAUTIONS**

9. Use proper safety precautions to guard against needle sticks.
10. Follow manufacturer instructions when using centrifuge. Use only EmCyte provided general purpose centrifuge. Outcomes using centrifuges from other manufacturers are unknown.
11. Do not use sterile components of this system if package is opened or damaged.
12. Single use device. Do not reuse. Do not attempt to clean or re-sterilize this product.
13. Do not use after expiration date.
14. Use prepared PRP within 4 hours after drawing blood according to current AABB guidelines.

**POSSIBLE RISKS**

15. The patient is to be made aware of the general risks associated with whole blood aspiration. These risks include, but are not limited to: hemorrhage, seroma formation, infection, and/or persistent pain at the site of aspiration.
16. Reuse may be a potential biohazard

**POSSIBLE ADVERSE EFFECTS**

17. Damage to blood vessels, hematoma, delayed wound healing and/or infection is associated with blood draw, and/or surgical procedure.
18. Temporary or permanent nerve damage that may result in pain or numbness is associated with blood draw, and/or surgical procedure.
19. Early or late postoperative infection is associated with surgical procedure.
20. Pain associated with site of whole blood harvest.

**STERILITY**

21. The PurePRP® SupraPhysiologic Concentrating System kits are sterilized by ETO exposure. Do not use any component from an opened or damaged package. Do not resterilize. Discard if kit packaging is damaged or open.















## INSTRUCTIONS FOR USE FOR 30mL SYSTEM

### PREPARATION PROTOCOL:

32. **NOTE:** Use standard sterile aseptic technique throughout the following procedure. Always swab needle-less ports with alcohol before and after accessing.
33. **WHOLE BLOOD DRAW:** Attach the sterile filter needle onto the sterile 30mL syringe. Draw 3mL of Citrate Anticoagulant into the 30mL syringe. Remove the filter needle from the syringe. Attach the butterfly needle onto 60mL syringe and prime the needle with the anticoagulant. Slowly draw 27mL of whole blood from the patient filling the syringe to 30mL. Gently, but thoroughly mix the blood and anticoagulant upon collection to prevent coagulation.

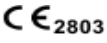
### CONCENTRATING PROTOCOL:



34. **LOAD: IMPORTANT: Attach sterile non-vented clear cap to the bottom port of the device. The clear cap MUST be always attached to the bottom port before centrifugation. WITH WHITE VENT OPEN,** slowly add the anticoagulated whole blood through the top port of the Concentrating Device. **THEN CLOSE WHITE VENT.**
35. **BALANCE:** Make sure the counterbalance device contains the same amount of volume as the Concentrating Device. Then place them directly opposite to each other in the centrifuge rotor buckets.
36. **FIRST SPIN:**
  - a. Platinum Series Centrifuge: Close the lid and set to **TIMER 1:30.**
  - b. Executive Series Centrifuge: Close the lid and set to **1.5 minutes and 3.8 x 1000 RPM (3800 RPM).**
  - c. Press the start button. Once the centrifuge stops, remove the Concentrating Device.
37. **FIRST EXTRACTION & TRANSFER:** Attach the sterile 30mL syringe to the top port.
  - a. **Protocol A** - Slowly aspirate the platelet plasma suspension (PPS) into the 30mL syringe. (Optionally, aspirate additional **0.5mL of RBC for optimal platelet recovery.**)
  - b. **Protocol B** - Slowly aspirate the platelet plasma suspension (PPS) and approximately **1mL of RBC** into the 30mL syringe. Remove the clear cap from the bottom port and inject the PPS solution through it. Recap the bottom port with sterile non-vented clear cap.
38. **SECOND SPIN:** Place Concentrating Device back into the centrifuge rotor bucket directly opposite the counterbalance device.
  - d. Platinum Series Centrifuge: Close the lid and set to **TIMER 2:45.**
  - e. Executive Series Centrifuge: Close the lid and set to **3 minutes and 3.8 x 1000 RPM (3800 RPM).**
  - f. Press the start button. Once the centrifuge stops, remove the Concentrating Device.
39. **SECOND EXTRACTION:** Remove the clear cap from the bottom port. Using the 30mL syringe, aspirate plasma from the bottom port leaving 3-4mL in the device.
40. **RESUSPEND THE PRP:** Gently swirl the Concentrating Device to re-suspend the platelet concentrate into the plasma.
41. **EXTRACT PRP:** Attach a sterile 12mL syringe to the bottom port and tilt to aspirate the platelet rich plasma through the open port of the aspirating pipe. Remove sterile syringe and apply a sterile cap.

 Do not use if package is damaged	 Attention, read instruction for use	 Single use only	 Store in a cool place	 Rx Only Prescription Use	
 <b>STERILE EO</b>	 Do not re-sterilize	 Consult instruction for use	 Store in a dry place	Australian Sponsor Emergo Australia, Level 20 Tower II, Darling Park, 201 Sussex Street Sydney, NSW 2000, Australia	 Non-pyrogenic
 <b>CE 2803</b>	 <b>MD</b> Medical Device	 <b>EC REP</b>	Authorized Representative Emergo Europe Prinsessegracht 20 2514 AP The Hague The Netherlands	 EmCyte Corporation 4331 Veronica S. Shoemaker Blvd. Fort Myers, FL 33916 Phone: 239-481-7725	

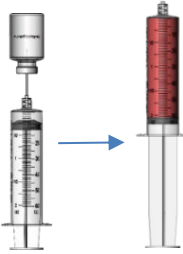

**GS30-SP: IFU ILLUSTRATION**

**NOTICES: ALWAYS SWAB SELF-SEALING PORT WITH STERILE ALCOHOL PRIOR TO ACCESSING WITH A STERILE SYRINGE**

**PREPARATION PROTOCOL**

<p><b>STEP 1:</b></p>  <p>Using the filtered needle, draw 3mL of Sodium Citrate Anticoagulant into 30mL syringe. Then collect 27mL whole blood filling syringe to 30mL.</p>	<p><b>STEP 2:</b></p> <p><b>ATTACH CLEAR NON-VENTED CAP</b></p>  <p>Attach clear non vented cap to the bottom port.</p>
--	--

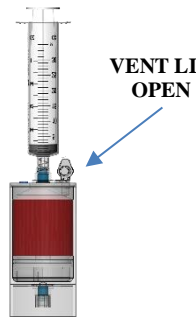
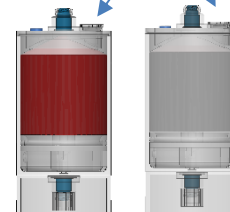
**CONCENTRATING PROTOCOL**

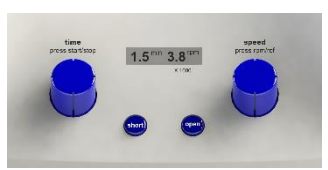
<p><b>STEP 3:</b></p>  <p><b>VENT LID OPEN</b></p> <p>With <b>VENT LID OPEN</b> Inject anticoagulated whole blood through the top needle-less port.</p>	<p><b>STEP 4:</b></p> <p><b>VENT LID CLOSED</b></p>  <p>Close <b>VENT LID</b> and counterbalance device with equal volume</p>  <p>Place in the centrifuge rotor at opposite ends.</p>	<p><b>STEP 5:</b></p>  <p><b>Platinum Series Centrifuge</b> Set to <b>*Timer: 1:30*</b></p>	 <p><b>Executive Series</b> Set to <b>1.5 minutes and 3800 rpm.</b></p>
---	---	---	--

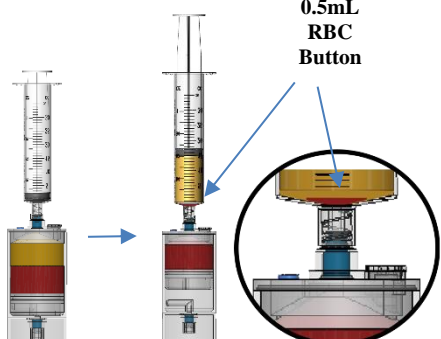
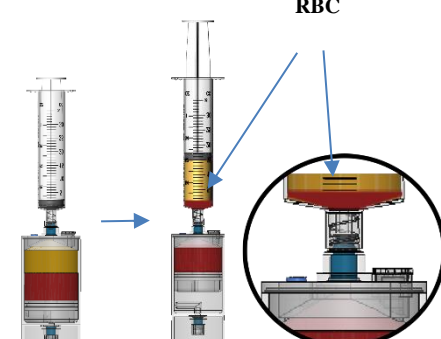
<p><b>STEP 6: PROTOCOL A</b></p>  <p><b>Optional 0.5mL RBC Button</b></p> <p><b>PROTOCOL A:</b> Connect the 30mL syringe to the top port and aspirate the platelet plasma suspension (PPS) into the 30mL syringe. Aspirate additional 0.5mL of RBC for optimal platelet recovery.</p>	<p><b>STEP 6: PROTOCOL B</b></p>  <p><b>1mL RBC</b></p> <p><b>PROTOCOL B:</b> Connect the 30mL syringe to the top port and aspirate the platelet plasma suspension (PPS) into the 30mL syringe. Aspirate additional 1mL of RBC.</p>
--	---

**STEP 7:**

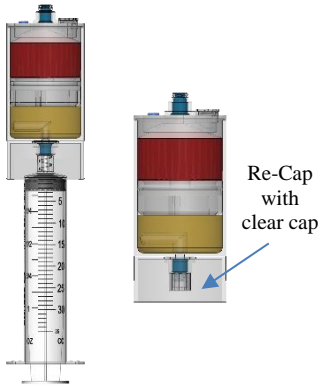

Inject PPS solution into the device through the bottom port. Then recap with sterile clear cap.

**STEP 8:**

Place back in centrifuge rotor.  
Process at:



**Platinum Series Centrifuge**  
Set to  
**\*Timer: 2:45\***



**Executive Series**  
3 minutes and 3800

**STEP 9:**

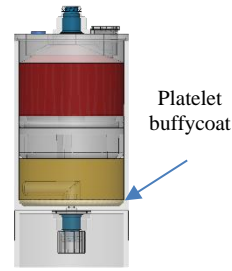

After centrifugation, the platelet buffycoat will be separated at the bottom of the device.

**STEP 10:**

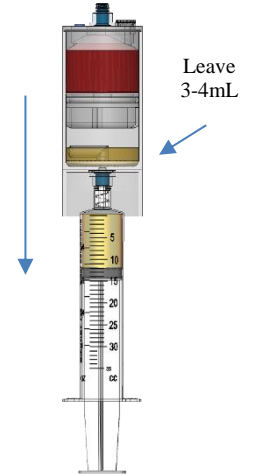

Connect the syringe to the bottom needle-less port and aspirate plasma, leaving 3-4mL in the device.

**STEP 11:**

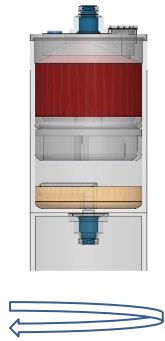

Gently swirl to resuspend the platelet buffycoat into the plasma.

**STEP 12:**

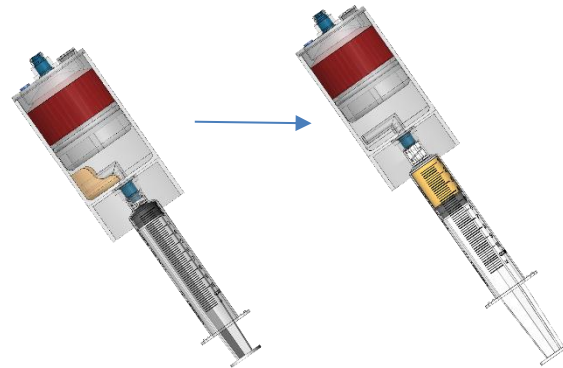

Connect the 12mL syringe to the bottom needle-less port and tilt to aspirate the PRP from the open port of the Aspirating Pipe.

**STEP 13:**



**3-4mL  
Clinical PRP**